

ERGONOMIC CHAIRS

SAMURAI

Japan



metta.pro

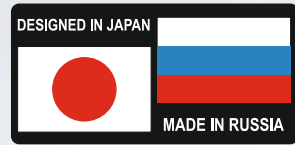



Company Metta – Leading office and HoReCa seating manufacturer and supplier in Russia and East Europe. We successfully sell our products on the EU market since 2016.

Samurai Series have recently been certified to meet European Union EN 1335 standard

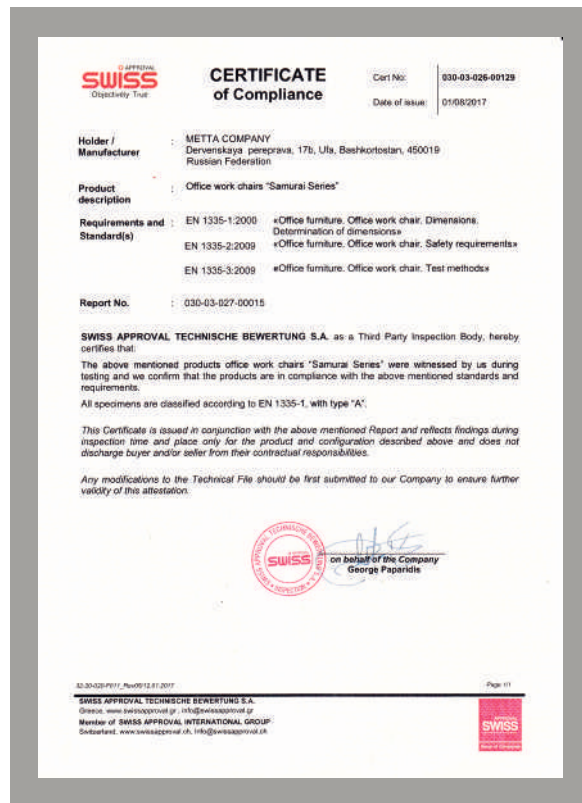

SAMURAI CHAIRS WITH UNIQUE ERGONOMIC FEATURES, GUARANTEE HIGH STAFF CAPACITY

It is well known:

Comfortable ergonomic work space increases staff capacity by 40%

[Bundesantalt für Arbeitsschutz und Arbeitsmedizin, bAuA]

- ✓ overall sense of well-being improvement
- ✓ elevation of attentiveness
- ✓ high level of concentration
- ✓ the number of errors decrease

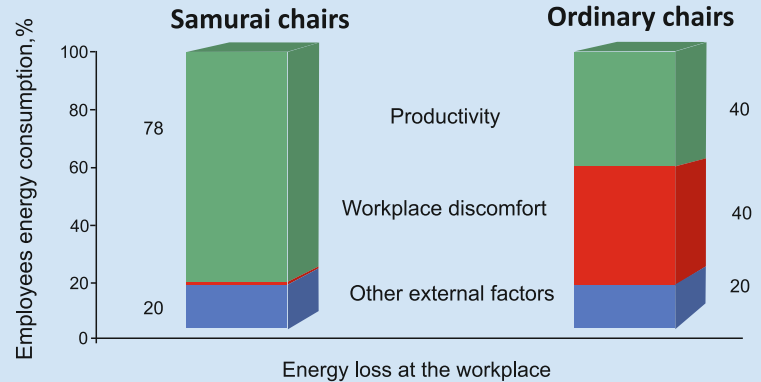

The cost of Samurai chairs is reimbursed in two months, and then, provide a tangible income

1) Due to increase of productivity

According to Schwarz & Neumann forschung Unternehmen GmbH only due to increased employee productivity, the Samurai chair pays off within 1 month:

$$2\,100 \times 0,15 \times 11 = 3\,465 \text{ €}$$

(personnel productivity for 1 month)

(15%-minimal productivity enhancement using Samurai)

(month)



Net profit per an employee by Samurai chair operating

3 715 €



Chair cost will be reimbursed in 2 months:

$$250 / (2\,100 \times 0,15) = 0,7$$

(cost of chair)

(personnel productivity for 1 month)

(15%-minimal productivity enhancement using Samurai)



250 €

The average cost of chair



The average cost of Samurai chair is only 250 €

2) Reduce the number of sick leave days

Non-ergonomic workplace causes 30% office employees diseases [Gesundes sitzen. StolComfort]

One day absence of a qualified professional at work costs the company on average 100€, Even 5 days Your staff "Sick leave" reduction, brings Your company 500 € income per year

3 715 €* of pure income
after 1 year of usage

$$*3\,465 + 500 - 250 = 3\,715$$

WARRANTY

FOR METAL FRAME

10 YEAR





ABSOLUTE ERGONOMICS

“Synchro mechanism” is the most ergonomic and modern tilting mechanism of chairs for now. Its kinematics corresponds human body anatomy. This mechanism changes the seat declination angle along with backrest declination, according to human body anatomy. That provides proper seating and body support in every position.

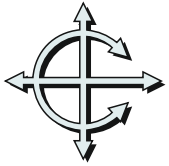

3D REMOVABLE HEADREST



Steel structural frame has absolute ergonomic shape of the backrest and the seat

Independent, synchronized backrest declination allows the person to bend and unbend in proper sitting position, while tilting. That improves legs blood flow, and massages muscles.

Ergonomic Samurai chair accurately adjusts to individual physical characteristics and allows you to take proper position, providing absolute comfort and convenience

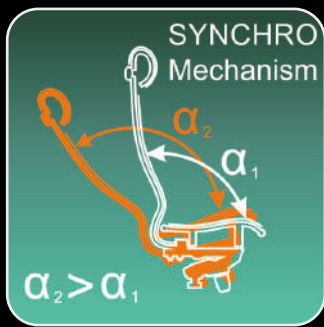

Separate seat and backrest tilting with the possibility of locking in each position.



Two-zone lumbar support hardness adjustment



Mesh fabric and perforated NewLeather enables your body to "breathe"



Absolutely ergonomic anatomic shape of the backrest and the seat



For metal frame



Two-zone seat hardness adjustment



Height, depth and tilting angle adjustments of 3D headrests



4D armrest adjustment: height, armrest pad width, armrest pad depth, armrest pad shifting angle



Without any load, chair wheels brake



5 position seat depth adjustment



Shifted tilting center makes it possible to keep feet on the floor when the chair is tilted



5 position backrest recline adjustment

INNOVATIVE ERGONOMIC CHAIRS SAMURAI

Chair Samurai S-1.03

Extra strong steel-frame covered with mirror chrome coating. 10 years warranty for structural frame

Soft comfortable headrest from wearproof perforated material NewLeather

Extra strong material – mesh fabric reinforced with aramid fiber

CREATED IN JAPAN
MADE IN RUSSIA

Ergonomic shape of the backrest corresponds to the anatomic human body shape

Wearproof armrests From material NewLeather

Two-zone lumbar support adjustment

Extra comfortable dual-reg seat

Two-zone seat hardness adjustment

Separate seat and backrest tilting with the possibility of locking in each position

Seat's depth adjustment

Shifted swinging center makes it possible to keep feet on the floor when the chair is tilted and prevents leg vessels constriction

Chair height adjustment

Swinging synchro mechanism hardness adjustment

Polished aluminium base

Polyurethane antirecoil castors are strong, durable and noiseless, leave no traces or scratches on the floor

Change of the seat tilt angle by tightening mesh fabric on front and back zones





Samurai SL-1.03

[mesh fabric backrest,
cushioned leather seat]

SERIES 1

New era of the World's ergonomic chairs!

- Soft detachable headrest
- High ergonomic chair backrest
- Comfortable steel – frame armrests with natural leather pads



Samurai K-1.03

[leather seat and
the backrest]



Samurai KL-1.03

[leather backrest,
cushioned seat]

INNOVATIVE ERGONOMIC CHAIRS SAMURAI

Chair Samurai K-2.03

Height, depth and tilting angle adjustments of 3D headrest

Extra strong steel-frame covered with mirror chrome coating. 10 years warranty for structural frame

Ergonomic shape of the backrest corresponds to the anatomic human body shape

Two-zone lumbar support hardness adjustment

Two-zone seat hardness adjustment

Shifted swinging center makes it possible to keep feet on the floor when the chair is tilted and prevents leg vessels constriction

Seat's depth adjustment

Chair height adjustment

Polished aluminium base

Polyurethane antirecoil castors are strong, durable and noiseless. leave no traces or scratches on the floor

CREATED IN JAPAN
MADE IN RUSSIA

Chair upholstery is made of wearproof perforated material NewLeather

Wearproof armrests from material NewLeather

Extra comfortable dual-reg seat

Separate seat and backrest tilting with the possibility of locking in each position

Swinging synchro mechanism hardness adjustment

Change of the seat tilt angle by tightening mesh fabric on front and back zones

SERIES 2

New level of the workspace ergonomics

- Height, depth and tilting angle adjustments of 3D headrest
- Shortened ergonomic backrest
- Comfortable steel – frame armrests with natural leather pads

Samurai S-2.03

[mesh fabric backrest and seat]



Samurai SL-2.03

[mesh fabric backrest, cushioned leather seat]



Samurai KL-2.03

[leather backrest, cushioned seat]



INNOVATIVE ERGONOMIC CHAIRS SAMURAI

Chair Samurai S-3.03

Height, depth and tilting angle adjustments of 3D headrest

Extra strong steel-frame covered with mirror chrome coating. 10 years warranty for structural frame

Ergonomic shape of the backrest corresponds to the anatomic human body shape

Two-zone lumbar support hardness adjustment

Two-zone seat hardness adjustment

Shifted swinging center makes it possible to keep feet on the floor when the armchair is tilted and prevents leg vessels constriction

Seat's depth adjustment

Chair height adjustment

Polished aluminium base

Polyurethane antirecoil castors are strong, durable and noiseless, leave no traces or scratches on the floor

CREATED IN JAPAN
MADE IN RUSSIA

Extra strong material – mesh fabric reinforced with aramid fiber

Height, depth and tilting angle adjustments of 4D armrests

Extra comfortable dual-reg seat

Separate seat and backrest tilting with the possibility of locking in each position

Swinging synchro mechanism hardness adjustment

Change of the seat tilt angle by tightening mesh fabric on front and back zones



Samurai K-3.03

[leather seat and the backrest]

SERIES 3

It combines 100 years of office chair production experience!

- Removable 3D Headrest is adjustable in any comfortable position: height, depth and tilting angle
- Shortened ergonomic backrest
- Height, armrest pad width, armrest pad depth, armrest pad shifting angle adjustments of 4D armrests



Samurai SL-3.03

[mesh fabric backrest, cushioned leather seat]



Samurai KL-3.03

[leather backrest, cushioned leather seat]

INNOVATIVE ERGONOMIC CHAIRS SAMURAI

Chair Samurai Comfort

Extra strong steel-frame covered with mirror chrome coating.
10 years warranty for structural frame

Soft comfortable headrest from wearproof perforated material
NewLeather

Ergonomic shape of the backrest corresponds to the anatomic human body shape

Wearproof armrests
From material NewLeather

Two-zone lumbar support adjustment

Separate seat and backrest tilting with the possibility of locking in each position

Chair height adjustment

Shifted swinging center makes it possible to keep feet on the floor when the chair is tilted and prevents leg vessels constriction

Polished aluminium base

Swinging synchro mechanism hardness adjustment





Upholsteries and colors available

Mesh fabric reinforced with aramid fiber

Mesh fabric reinforced with aramid fiber. Polymeric woven fabric with incredible strength and durability. Involving aramid fiber into the fabric increases its strength. Totally eco-friendly and infinitely durable material. Colors available: black, beige, dark burgundi, dark brown, blue, grey

Durable perforated material NewLeather

Innovative eco-friendly material reinforced with nylon fiber, makes fibrous natural basis due to which this material is highly competitive with the natural leather in such properties as elasticity, strength and durability. Moreover perforation provides unique "breathing" properties competitive even with fabric and considerably exceeding "breathing" properties of ordinary natural leather. Colors available: black, beige, dark burgundi, dark brown

He highest quality top-grain leather

The highest quality top-grain leather - is the natural top surface of the hide which provides the most beauty and durability, softy and gracefully supple. The outer section of the skin has a cross arrangement of fibers giving it its high strength, creating the leather's tensile strength. It made from the highest quality raw hides are sourced from cattle. This type of leathers boast superior seating comfort as they are able to breathe. Colors available: black, beige, bordeaux, dark brown



PYTHON EDITION black

Glossy genuine leather with PYTHON EDITION embossing for headrest and armrests samurai chairs



Black Alligator

Eco-leather with «Alligator» embossing for headrest and armrests Samurai chairs



White Swan

Pearly White glittering upholstery "White Swan" is perforated durable material New Leather. All Samurai chairs feature New Leather upholstery

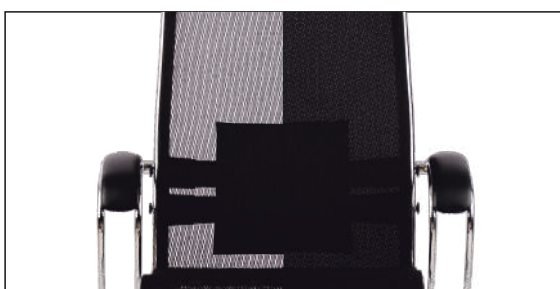

BLACK PLUS

Double-layer mesh fabric makes the Samurai S chairs non-transparent

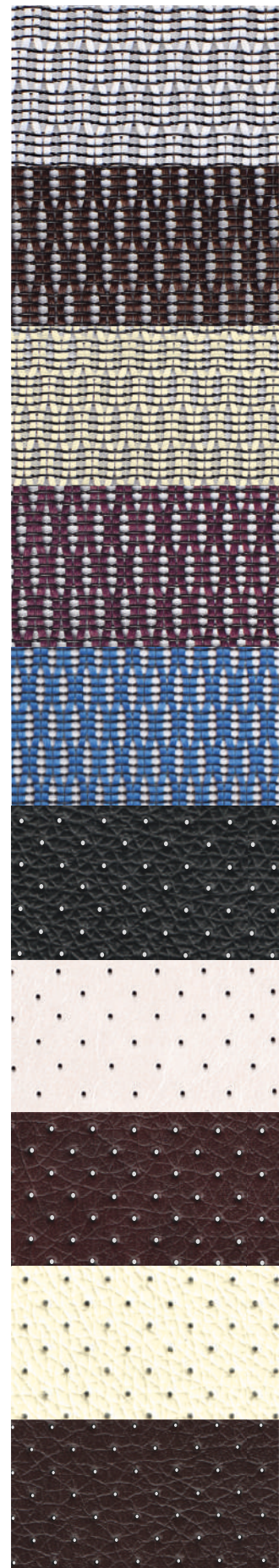



Samurai chair series options layout



Comfortable detachable headrest made of durable perforated material NewLeather (for «Samurai 1»)



Removable 3D Headrest is adjustable in any comfortable position:
- height; - depth; - tilting angle
(for «Samurai 2», «Samurai 3»)



Soft and comfortable armrests made of durable material NewLeather (for «Samurai 1» and «Samurai 2»)



Height, armrest pad width, armrest pad depth, armrest pad shifting angle adjustments of 4D armrests
(for «Samurai 3»)



Soft seat matt Csm-10 features perforated durable material NewLeather. This seat matt provides more comfortable contact with the mesh seat and better warmth during winter season. Matt is 10 mm thick (available with «Samurai S-1», «Samurai S-2», «Samurai S-3»)











Super Soft seat matt Csm-25 features perforated durable material NewLeather. This seat matt provides excellent comfort and better warmth during winter season. Matt is 25 mm thick. (available with «Samurai S-1», «Samurai S-2», «Samurai S-3»)





More than 12 models include 5 color options available

	Serie 1 Soft comfortable headrest Comfortable armrests	Serie 2 Removable 3D headrest Comfortable armrests	Serie 3 Removable 3D headrest Comfortable 4D armrests
Model S: The seat and the backrest are covered with durable mesh fabric	 <p>SAMURAI S-1.03</p>	 <p>SAMURAI S-2.03</p>	 <p>SAMURAI S-3.03</p>
Model K: leather seat and the backrest	 <p>SAMURAI K-1.03</p>	 <p>SAMURAI K-2.03</p>	 <p>SAMURAI K-3.03</p>
Model SL: mesh fabric backrest and cushioned leather seat	 <p>SAMURAI SL-1.03</p>	 <p>SAMURAI SL-2.03</p>	 <p>SAMURAI SL-3.03</p>
Model KL: leather backrest and cushioned leather seat	 <p>SAMURAI KL-1.03</p>	 <p>SAMURAI KL-2.03</p>	 <p>SAMURAI KL-3.03</p>
Samurai chairs S-1, S-2, S-3 with leather seat mat	 <p>SAMURAI S-1.03 Mat Csm-10</p>	 <p>SAMURAI S-2.03 Mat Csm-10</p>	 <p>SAMURAI S-3.03 Mat Csm-25</p>

Model	Headrest		Armrests		Seat			Backrest	
	comfortable	removable 3D headrest	fixed armrests	4D adjustable	soft foam filled leather look seat	mesh	stretch leather look seat	mesh	stretch leather look backrest
									
Samurai S-1.03	✓		✓			✓		✓	
Samurai S-2.03		✓	✓			✓		✓	
Samurai S-3.03		✓		✓		✓		✓	
Samurai SL-1.03	✓		✓		✓			✓	
Samurai SL-2.03		✓	✓		✓			✓	
Samurai SL-3.03		✓		✓	✓			✓	
Samurai K-1.03	✓		✓				✓		✓
Samurai K-2.03		✓	✓				✓		✓
Samurai K-3.03		✓		✓			✓		✓
Samurai KL-1.03	✓		✓		✓				✓
Samurai KL-2.03		✓	✓		✓				✓
Samurai KL-3.03		✓		✓	✓				✓

Chair dimensions

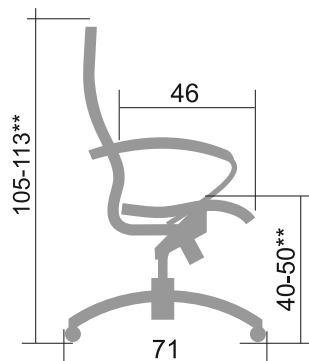
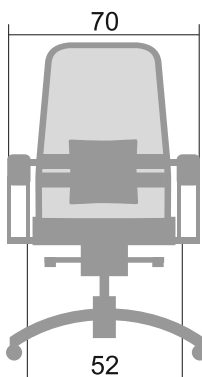
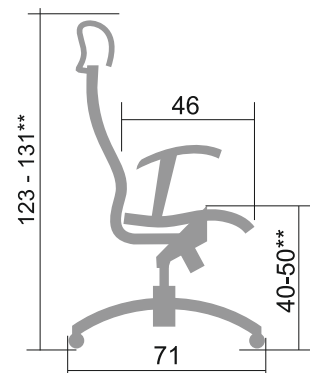
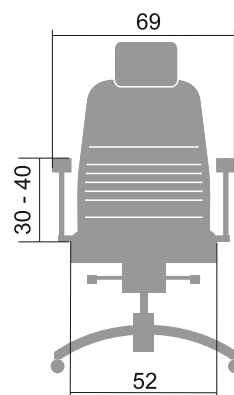
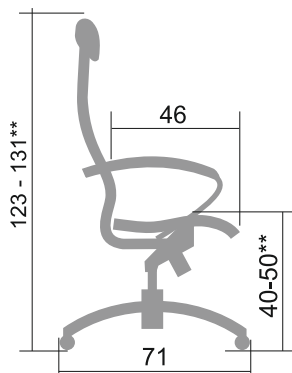
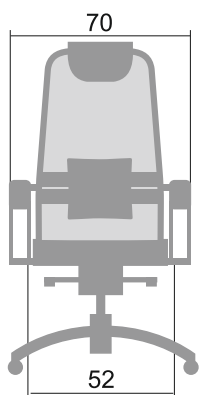

Box dimensions

V = 0,15 m³
P ≈ 26 kg

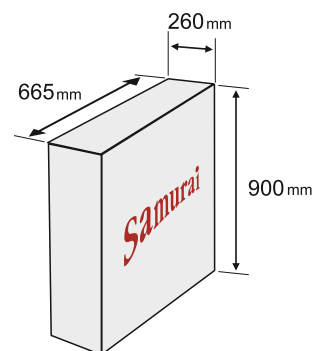

** Height changes are possible in case of gas spring replacement

SAMURAI

Japan



DESIGNED IN JAPAN



MADE IN RUSSIA



CERTIFIED IN
SWITZERLAND